

FLOOR RETICULATION

CABSTRUT®

UNDER SCREED DUCTING SYSTEM (Sub-surface Outlets Protected from Damage)

- 3000mm standard length
- Breakout outlet points at 500mm centres
- Duct installed 35mm below surface level
- Overall depth 75mm minimum
- Galvanised (PG) 1,2mm construction
- Alternative installation method available on request

1590.00

DUCT OUTLET KIT COMPRISING:

Disposable Concrete Ingress Prevention Plate

Screed Frame

Modular Outlet Plates

Fit Duct Outlet Kit to Duct prior to screeding of Floor Duct

4950.00

3UAA Duct
220 x 350mm Deep

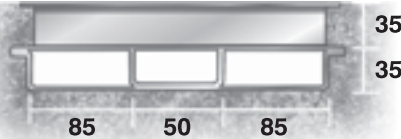

Standard Accessories

3UA Universal Drawbox
300 x 300 x 65mm

2520.00

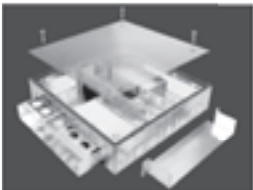

External Splice
(For cut lengths)

151.80



Internal Splice
(For standard lengths)

151.80



Power Skirting Connector
3UAA - P801
3UAA - P803

506.00

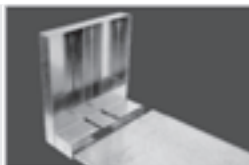

ACCESS FLOOR/CONDUIT BOX SYSTEM (Sub-surface Outlets Protected from Damage)

- System fits into access floor tile (208 x 288mm aperture)
- Can also fit onto conduit floor box cast into the floor and fed by conduit

1020.00

PVC Carpet Frame & Lid
200 x 300mm

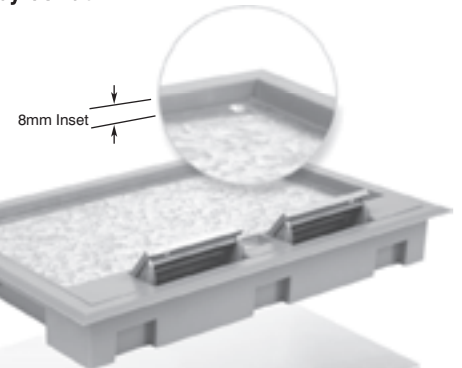

Suitable for 20 & 25mm Conduit

Brushed S/Steel Walkway Outlet Box Kit
(Suitable for Tile Application)
238.5 x 238.5 x 70mm Deep
i0016940

5625.00

SS304 Brushed S/Steel Frame & Lid Adjustable to Align with Tile

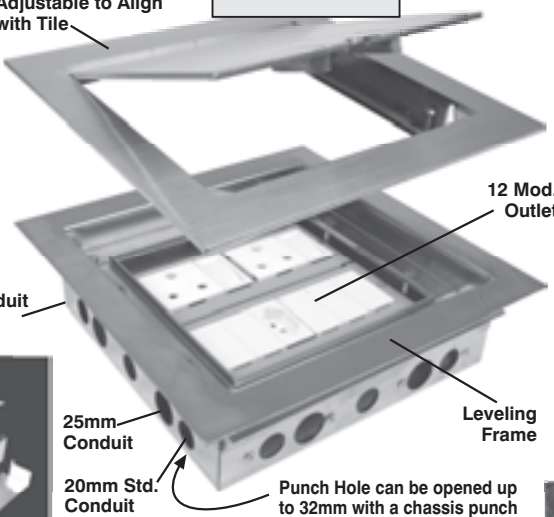

1940.00

CONDUIT BOX OUTLET KIT COMPRISING:
Disposable Concrete Ingress Prevention Plate, Conduit Box and Modular Outlet Plates

Conduit Access Floor Box
205 x 287 x 70 or 100mm Deep

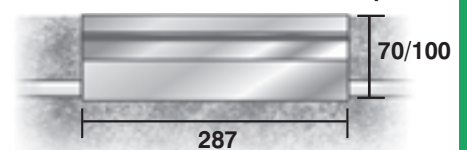

70mm Conduit Access Floor Box cannot use DR11459/11460. For more information see pages 9/10/11

Universal Modular Outlet Plate

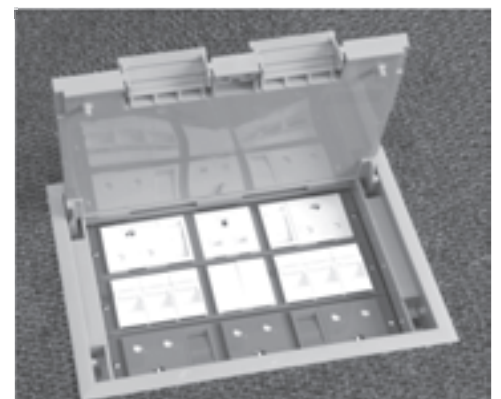

FLOOR RETICULATION

FLUSH DUCTING WITH SURFACE MOUNTED OUTLET PEDESTALS 3F FLOOR DUCT

- 3000mm standard length
- Removable outlet covers at 1000mm centres
- Galvanised (PG) 2mm top and 1mm base
- 31mm installation depth
- FD2, FD3 & FD4 pedestals can be fitted

Aesthetic textured powder coating options:
Motor Craft Grey, Carrier Beige, Hammertone Grey, White, Easter Oak, Hospital Grey & Satin Smooth Black Finish

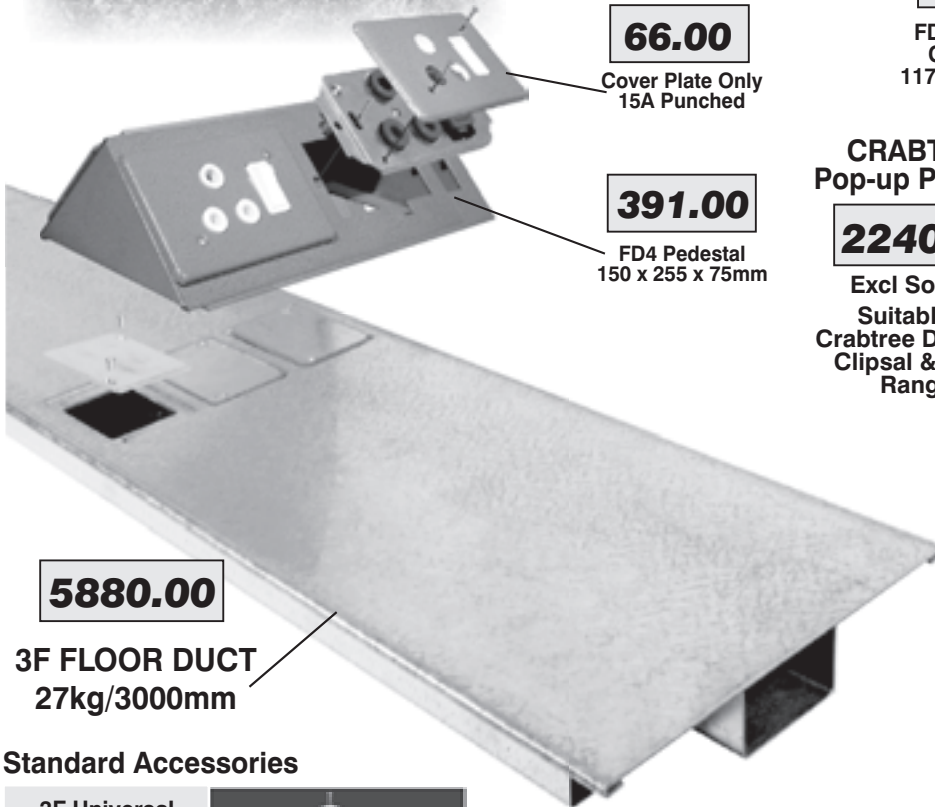
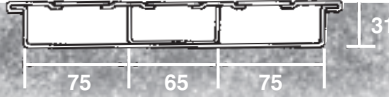

5880.00
3F FLOOR DUCT
27kg/3000mm

350.00

FD2 Pedestal
Conduit Box
117 x 135 x 38mm

244.00

FD2 Pedestal
140 x 150 x 75mm

345.00

FD3 Pedestal
230 x 140 x 75mm

66.00

Cover Plate Only
15A Punched

391.00

FD4 Pedestal
150 x 255 x 75mm

495.00

FD3/4 Pedestal
Conduit Box
117 x 210 x 38mm

**CRABTREE
Pop-up Pedestal**

2240.00

Excl Sockets
Suitable for
Crabtree Diamond,
Clipsal & Thynk
Ranges

Standard Accessories

3F Universal
Drawbox
300 x 300 x 65mm

2520.00

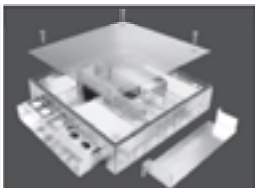

External Splice
(For cut lengths)

151.80



Internal Splice
(For standard lengths)

151.80



Power Skirting
Connector
3F - P801
3F - P803

506.00

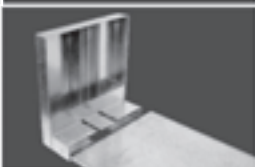

Universal
Modular Outlets
suitable for all
Modular systems
(Crabtree, Clipsal
& Thynk)

75x50mm
50x50mm

66.00



BLANK
COVER PLATE
66.00



ORDER CRADLE
SEPARATELY

(See Pages 9/10/11 For Socket & Switch Accessories)

OUTLET COVER KITS 66.00 EACH

6896H
15A SSO



Crabtree Outlet Options

4556H
13A SSO



20A DPI
20A DPI + CG



Clipsal Outlet Options

LS 2002
16A SSO



S2015PS/13
13A SSO



LS 1005
Universal Twin Cradle



WALL RETICULATION

CABSTRUT®

- Suitable for power, voice & data outlets
- Fit from front clip-on PVC covers
- Boxes suitable for single or double sided use

- Universal modular outlets suitable for all modular systems (Crabtree, Clipsal & Thynk)
- Order boxes, cradles, covers & outlets separately (for outlets & accessories see pages 9/10/11)

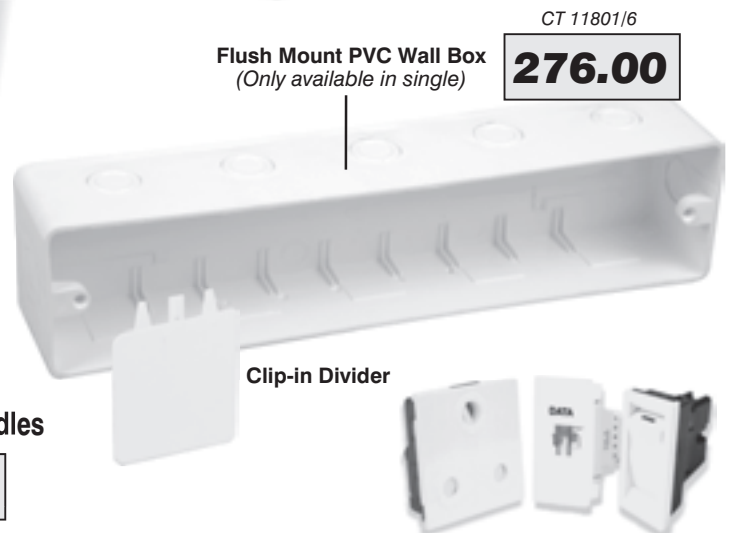
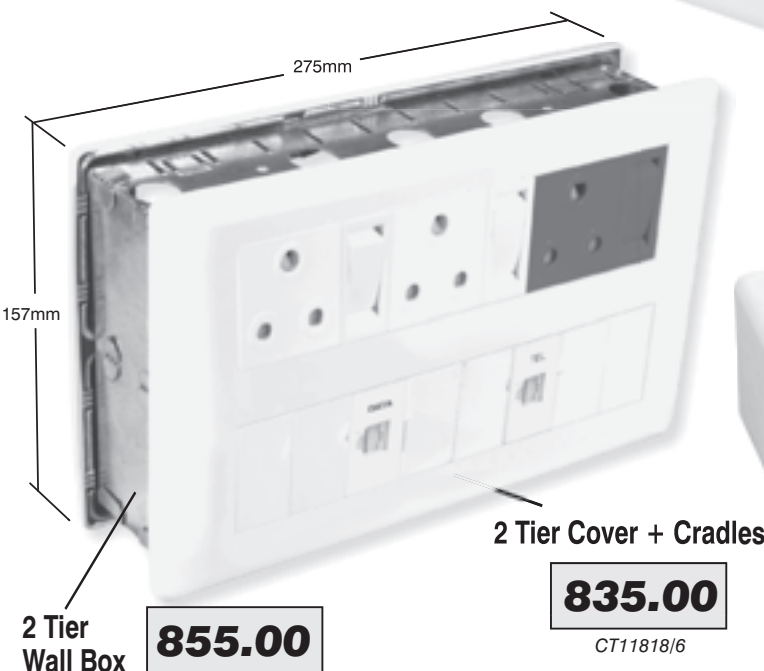
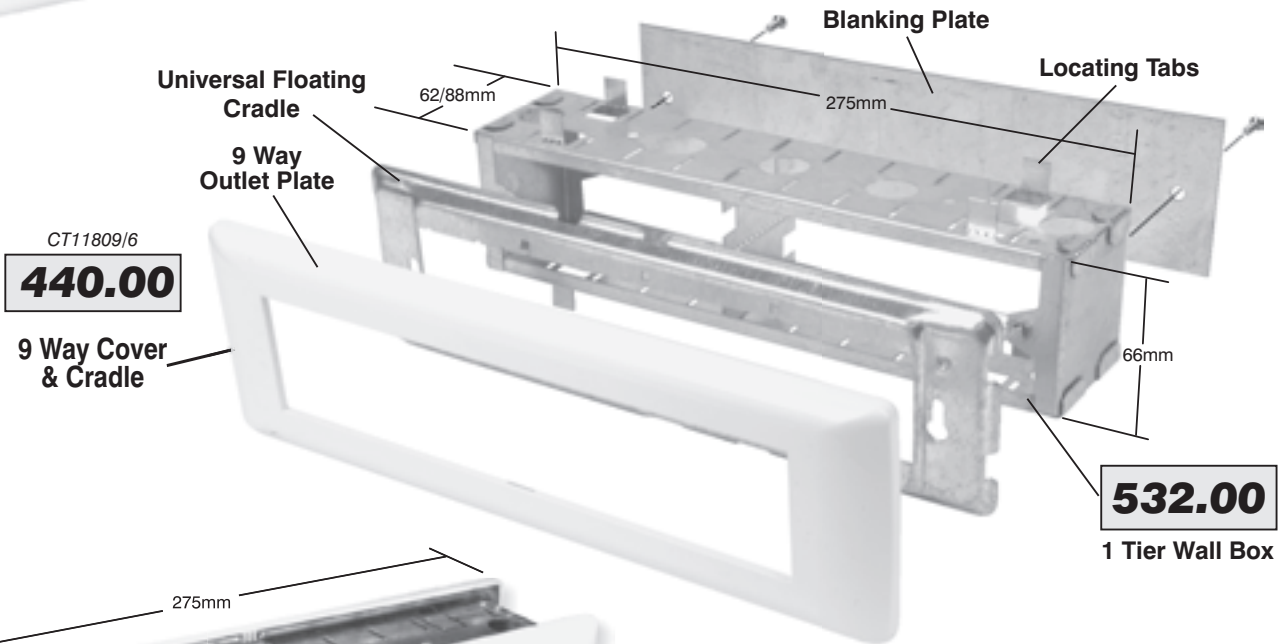
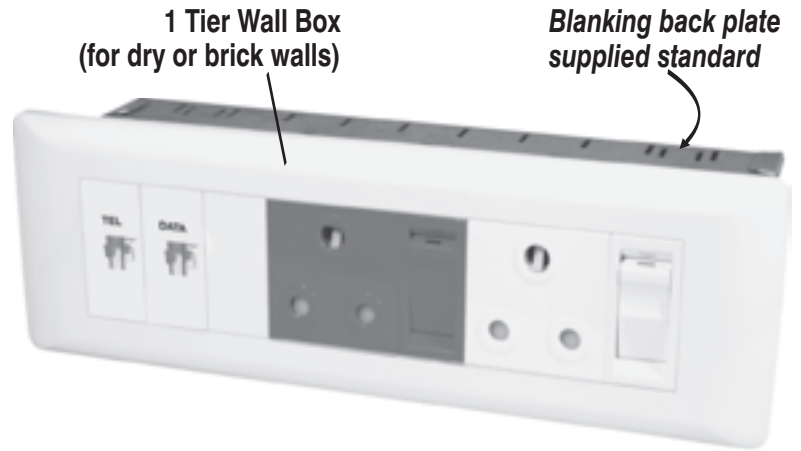
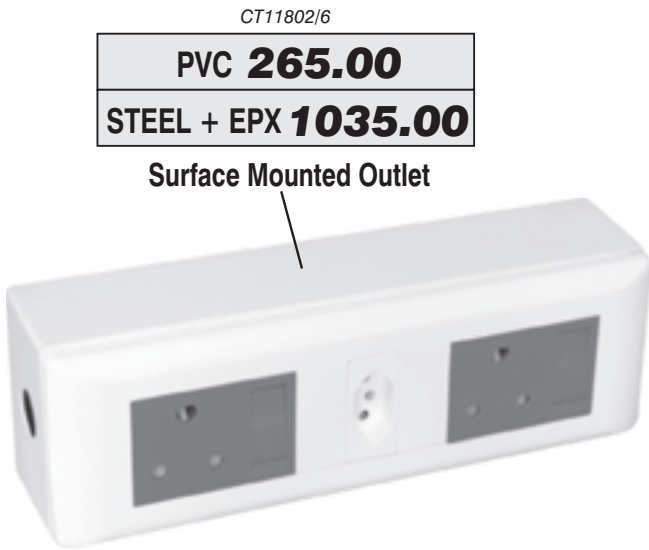

(See Pages 9/10/11 For Socket & Switch Accessories)