

THREADED ROD FIXINGS

Threaded Rod Hanger

Threaded Rod Hanger for fixing to vertical faces. Suits threaded rod M6, M8, M10 and M12. RH127 requires nut to secure.

REF	A (mm)	B Ø (mm)	C Ø (mm)		PRICE
RH6T	28	6.5	M6	68	15.60
RH8T	28	6.5	M8	68	15.60
RH10T	28	6.5	M10	68	15.60
RH127	28	6.5	12.7	68	15.60

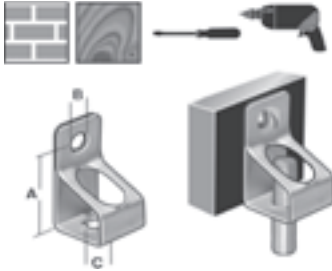

Large Beam Clip / Threaded Rod Hanger Combination

A simple cost-effective solution for fixing onto outsized steelwork Grips firmly onto flanges up to 30mm. Suits threaded rod M6, M8, M10 and M12. RH127 requires nut to secure.

REF	A (mm)	T (mm)	B Ø (mm)		PRICE
LBC2330-RH6T	25	23-30	M6	20	56.60
LBC2330-RH8T	25	23-30	M8	20	56.60
LBC2330-RH10T	25	23-30	M10	20	56.60
LBC2330-RH127	25	23-30	12.7	20	56.60

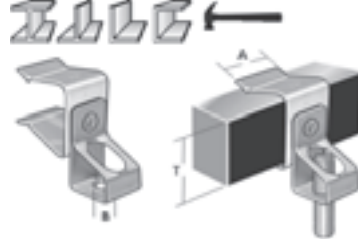

Right Angled Bracket / Threaded Rod Hanger Combination

Right Angle Bracket for soffit fixing. Incorporates Threaded Rod Hanger to suit rod diameters M6, M8, M10 and M12. RH127 requires nut to secure.

REF	A (mm)	B Ø (mm)	C Ø (mm)		PRICE
RAB26-RH6T	47	M6	6.5	68	33.70
RAB26-RH8T	47	M8	6.5	68	33.70
RAB26-RH10T	47	M10	6.5	68	33.70
RAB26-RH127	47	12.7	6.5	68	33.70
RAB44-RH6T	65	M6	6.5	68	35.00
RAB44-RH8T	65	M8	6.5	68	35.00
RAB44-RH10T	65	M10	6.5	68	35.00
RAB44-RH127	65	12.7	6.5	68	35.00



Beam Clip / Threaded Rod Hanger Combination

Beam Clip to suit horizontal flanges 1,5-20mm thick. Incorporating Threaded Rod Hanger for rod diameters M6, M8, M10 and M12. RH127 requires nut to secure.

REF	T (mm)	A (mm)	B Ø (mm)		PRICE
BC153-RH6T	1.5-3	44	M6	68	39.80
BC153-RH8T	1.5-3	44	M8	68	39.80
BC153-RH10T	1.5-3	44	M10	68	39.80
BC153-RH127	1.5-3	44	12.7	68	39.80

BC38-RH6T	3-8	46	M6	68	47.00
BC38-RH8T	3-8	46	M8	68	47.00
BC38-RH10T	3-8	46	M10	68	47.00
BC38-RH127	3-8	46	12.7	68	47.00

BC814-RH6T	8-14	54	M6	68	48.70
BC814-RH8T	8-14	54	M8	68	48.70
BC814-RH10T	8-14	54	M10	68	48.70
BC814-RH127	8-14	54	12.7	68	48.70

BC1420-RH6T	14-20	60	M6	68	50.60
BC1420-RH8T	14-20	60	M8	68	50.60
BC1420-RH10T	14-20	60	M10	68	50.60
BC1420-RH127	14-20	60	12.7	68	50.60

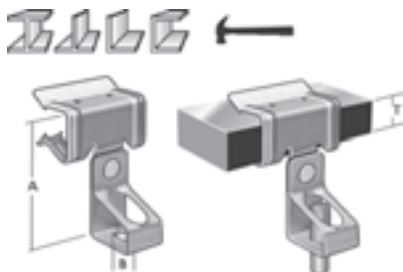

Vertical Flange Clip / Threaded Rod Hanger Combination

Hammer-on Vertical Flange Clip to suit flange thickness 1.5-7mm. Incorporates Threaded Rod Hanger for rod diameters M6, M8, M10 and M12. RH127 requires nut to secure.

REF	T (mm)	A (mm)	B Ø (mm)		PRICE
VF155-RH6T	1.5-5	70	M6	68	39.80
VF155-RH8T	1.5-5	70	M8	68	39.80
VF155-RH10T	1.5-5	70	M10	68	39.80
VF155-RH127	1.5-5	70	12.7	68	39.80
VF57-RH6T	5-7	70	M6	68	39.80
VF57-RH8T	5-7	70	M8	68	39.80
VF57-RH10T	5-7	70	M10	68	39.80
VF57-RH127	5-7	70	12.7	68	39.80



Height Adjustable Threaded Rod Hanger

Height Adjustable Threaded Rod Hanger Clip for fixing to vertical faces. Clip flexes to allow rapid adjustment of threaded rod. Suits threaded rod diameter M6, M8 & M10.

REF	A (mm)	B Ø (mm)	C Ø (mm)		PRICE
TRH6	55	6.5	M6	60	15.10
TRH8	55	6.5	M8	70	15.10
TRH10	55	6.5	M10	70	15.10



Vertical Flange Clip / Height Adjustable Threaded Rod Hanger Combination

Vertical Flange Clip to suit flanges 1.5-7mm thick, incorporating Height Adjustable Threaded Rod Hanger for threaded rod diameters M6, M8 & M10. Threaded rods adjusted by flexing clip with finger.

REF	T (mm)	A Ø (mm)		PRICE
VF155-TRH6	1.5-5	M6	60	43.10
VF155-TRH8	1.5-5	M8	70	43.10
VF155-TRH10	1.5-5	M10	70	43.10
VF57-TRH6	5-7	M6	60	43.10
VF57-TRH8	5-7	M8	70	43.10
VF57-TRH10	5-7	M10	70	43.10

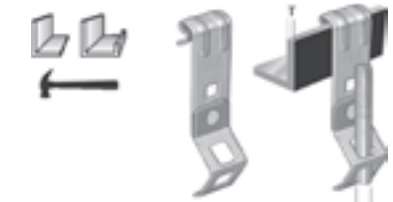

Master Clamp / Threaded Rod Hanger Combination

Screw Clamp for horizontal flanges up to 18mm. Incorporates Threaded Rod Hanger to suit rod diameters M6, M8, M10 and M12. RH127 requires nut to secure.

REF	T (mm)	A Ø (mm)		PRICE
SC107-RH6T	Max 18	M6	45	60.30
SC107-RH8T	Max 18	M8	45	60.30
SC107-RH10T	Max 18	M10	45	60.30
SC107-RH127	Max 18	12.7	45	60.30

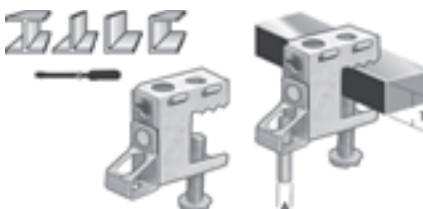

THREADED ROD FIXINGS

Master Clamp / Height Adjustable Threaded Rod Hanger Combination

Screw Clamp for horizontal flanges up to 18mm. Incorporates Adjustable Threaded Rod Hanger to suit rod diameters M6, M8 & M10.

REF	T (mm)	A Ø (mm)		PRICE
SC107-TRH6	Max 18	M6	25	59.80
SC107-TRH8	Max 18	M8	25	59.80
SC107-TRH10	Max 18	M10	25	59.80

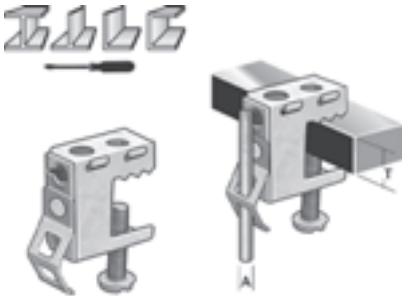

Height Adjustable Threaded Rod Hanger Combination

Double Clip for fixing threaded rod to threaded rod, diameters M6, M8 & M10 in various combinations (see tabulated information) Height adjustable by flexing clip with finger.

REF	A Ø (mm)	B Ø (mm)		PRICE
TRH6-TRH6	M6	M6	60	42.20
TRH6-TRH8	M6	M8	60	42.20
TRH6-TRH10	M6	M10	60	42.20
TRH8-TRH8	M8	M8	70	42.20
TRH8-TRH10	M8	M10	70	42.20
TRH10-TRH10	M10	M10	70	42.20

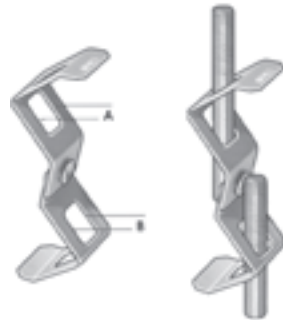

Beam Clip / Height Adjustable Threaded Rod Hanger Combination

Beam Clip for horizontal flange fixing, incorporating Height Adjustable Threaded Rod Hanger to suit threaded rod diameter M6, M8 & M10. Beam Clips suit flange thickness 2-20mm

REF	T (mm)	A Ø (mm)		PRICE
BC153-TRH6	1.5-3	M6	60	39.60
BC153-TRH8	1.5-3	M8	70	39.60
BC153-TRH10	1.5-3	M10	70	39.60
BC38-TRH6	3-8	M6	60	46.80
BC38-TRH8	3-8	M8	70	46.80
BC38-TRH10	3-8	M10	70	46.80
BC814-TRH6	8-14	M6	60	48.30
BC814-TRH8	8-14	M8	70	48.30
BC814-TRH10	8-14	M10	70	48.30
BC1420-TRH6	14-20	M6	60	50.40
BC1420-TRH8	14-20	M8	70	50.40
BC1420-TRH10	14-20	M10	70	50.40

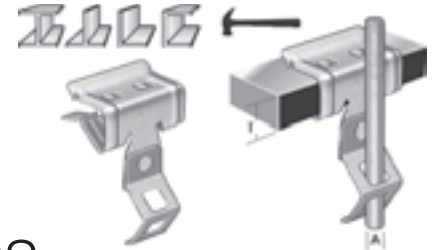

CABLE & TUBE FIXINGS

Cable Run Clip

Simple clip available in sizes to suit horizontal or vertical flanges from 2-12mm thick. Suitable for round conduit or cable.

REF	T (mm)	A Ø (mm)	PRICE
CRS4555	2-4	4.5-5.5	10.00
CRS67	2-4	6-7	10.00
CRS89	2-4	8-9	10.50
CRS1011	2-4	10-11	10.50
CRS1214	2-4	12-14	10.90
CRS1519	2-4	15-19	10.90
CRS2024	2-4	20-24	12.00
CRS2532	2-4	25-32	13.70
CRM4555	4-7	4.5-5.5	10.00
CRM67	4-7	6-7	10.00
CRM89	4-7	8-9	10.50
CRM1011	4-7	10-11	10.50
CRM1214	4-7	12-14	10.90
CRM1519	4-7	15-19	10.90
CRM2024	4-7	20-24	12.00
CRM2532	4-7	25-32	13.70
CRL4555	8-12	4.5-5.5	10.00
CRL67	8-12	6-7	10.00
CRL89	8-12	8-9	10.50
CRL1011	8-12	10-11	10.50
CRL1214	8-12	12-14	10.90
CRL1519	8-12	15-19	10.90
CRL2024	8-12	20-24	12.00
CRL2532	8-12	25-32	13.70

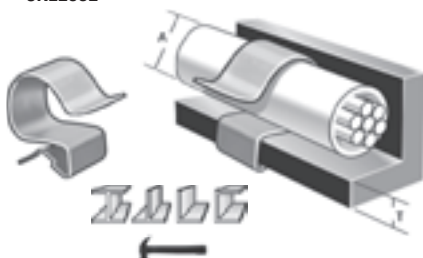

Support Clip

Spring clip for horizontal and vertical flanges or threaded drop rods. Designed to support conduit 16-40mm diameter. No tools required.

REF	A (mm)	B Ø (mm)		PRICE
<i>(For flanges)</i>				
SC313T	3-5	16-25	45	33.70
	6-9	16-20	45	33.70
	9-13	16	45	33.70
SC320T	3-5	20-38	45	35.70
	6-9	20-35	45	35.70
	9-13	20-30	45	35.70
	13-16	20-25	45	35.70
	16-20	20	45	35.70
<i>(For rod)</i>				
SC313T	M6/M8/M10	20 Max	22	33.70
SC320T	M6/M8/M10	40 Max	22	35.70

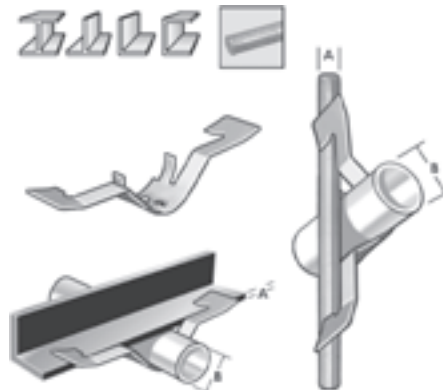

Snap-In Conduit Clip

For fixing to vertical or horizontal surfaces. Conduit snaps securely into position. Designed to support conduit 18-33mm diameter.

REF	A (mm)	B Ø (mm)	C Ø (mm)		PRICE
SICC1825	38	18-25	6.5	11	15.00
SICC2229	38	22-29	6.5	11	16.40
SICC2933	43	29-33	6.5	11	17.90

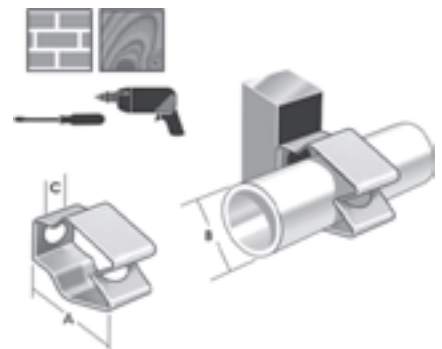

CABLE & TUBE FIXINGS

Locking Conduit Clip

For fixing to vertical or horizontal surfaces. Conduit/cable is held securely in position by locking mechanism. Use pliers to secure. Designed to support conduit/cable 12-57mm diameter.

REF	A (mm)	B Ø (mm)	C Ø (mm)	S	PRICE
LCC1219	44	12-19	6.5	45	23.80
LCC1926	44	19-26	6.5	45	25.90
LCC2632	55	26-32	6.5	45	28.50
LCC3240	68	32-40	6.5	45	31.60
LCC4047	79	40-47	6.5	45	33.70
LCC4757	87	47-57	6.5	45	43.60

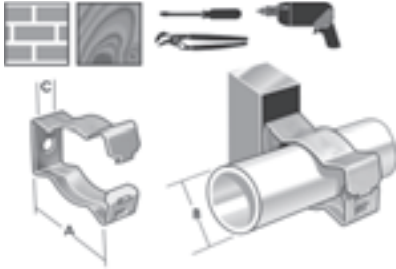

Double Run Snap-In Conduit Mount

Double Snap-in Conduit Clips to support multi-directional conduit. Supports conduit 18-33mm diameter. No tools required.

REF	A Ø (mm)	B Ø (mm)	U	PRICE
SICC1825-SICC1825	18-25	18-25	11	38.80
SICC1825-SICC2229	18-25	22-29	11	39.30
SICC1825-SICC2933	18-25	29-33	11	39.90
SICC2229-SICC2229	22-29	22-29	11	39.90
SICC2229-SICC2933	22-29	29-33	11	40.70
SICC2933-SICC2933	29-33	29-33	11	41.30

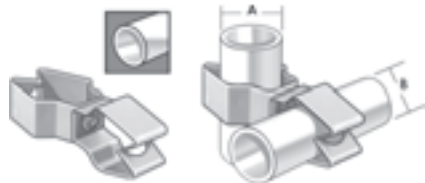

Beam Clip / Snap-In Conduit Clip Combination

Beam Clip with Snap-In Conduit Clip for fixing to horizontal or vertical flanges. Designed to support conduit 18-33mm diameter

REF	T (mm)	A Ø (mm)	U	PRICE
BC38-SICC1825	3-8	18-25	7	46.00
BC38-SICC2229	3-8	22-29	7	46.80
BC38-SICC2933	3-8	29-33	7	47.40
BC814-SICC1825	8-14	18-25	7	47.90
BC814-SICC2229	8-14	22-29	7	48.70
BC814-SICC2933	8-14	29-33	7	49.30
BC1420-SICC1825	14-20	18-25	7	49.60
BC1420-SICC2229	14-20	22-29	7	50.50
BC1420-SICC2933	14-20	29-33	7	51.10

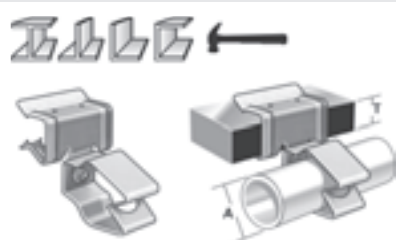

Double Run Locking Conduit Mount

Double Locking Conduit Clip to support multi-directional conduit. Use pliers to lock. Designed to support conduit 12-57mm diameter.

REF	A Ø (mm)	B Ø (mm)	U	PRICE
LCC1219-LCC1219	12-19	12-19	45	55.60
LCC1219-LCC1926	12-19	19-26	45	60.30
LCC1219-LCC2632	12-19	26-32	45	62.70
LCC1219-LCC3240	12-19	32-40	45	66.20
LCC1219-LCC4047	12-19	40-47	45	67.60
LCC1219-LCC4757	12-19	47-57	45	76.60
LCC1926-LCC1926	19-26	19-26	45	62.10
LCC1926-LCC2632	19-26	26-32	45	64.60
LCC1926-LCC3240	19-26	32-40	45	67.60
LCC1926-LCC4047	19-26	40-47	45	69.50
LCC1926-LCC4757	19-26	47-57	45	78.50
LCC2632-LCC2632	26-32	26-32	45	67.30
LCC2632-LCC3240	26-32	32-40	45	70.00
LCC2632-LCC4047	26-32	40-47	45	72.00
LCC2632-LCC4757	26-32	47-57	45	81.00
LCC3240-LCC3240	32-40	32-40	45	72.90
LCC3240-LCC4047	32-40	40-47	45	75.00
LCC3240-LCC4757	32-40	47-57	45	84.00
LCC4047-LCC4047	40-47	40-47	45	76.60
LCC4047-LCC4757	40-47	47-57	45	85.80
LCC4757-LCC4757	47-57	47-57	45	94.70

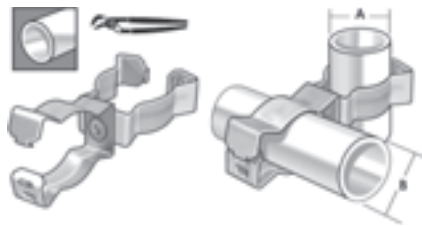

Beam Clip / Snap-In Conduit Combination - Reversed

Beam Clip with Snap-In Conduit Clip for fixing to horizontal or vertical flanges. Designed to support conduit 18-33mm diameter.

REF	T (mm)	A Ø (mm)	U	PRICE
BC38-SICC1825R	3-8	18-25	7	46.00
BC38-SICC2229R	3-8	22-29	7	46.80
BC814-SICC1825R	8-14	18-25	7	47.90
BC814-SICC2229R	8-14	22-29	7	48.70
BC814-SICC2933R	8-14	29-33	7	49.30
BC1420-SICC1825R	14-20	18-25	7	49.60
BC1420-SICC2229R	14-20	22-29	7	50.50
BC1420-SICC2933R	14-20	29-33	7	51.10

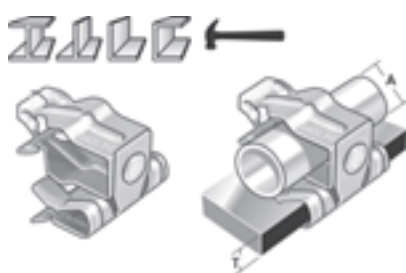

Beam Clip / Locking Conduit Clip Combination

Beam Clip with Locking Conduit Clip for fixing to horizontal or vertical flanges. Conduit is held adjacent to face of flange. Designed to support conduit/cables 12-57mm diameters.

REF	T (mm)	A Ø (mm)	U	PRICE
BC153-LCC1219	1.5-3	12-19	12	47.30
BC153-LCC1926	1.5-3	19-26	12	49.30
BC153-LCC2632	1.5-3	26-32	12	52.00
BC153-LCC3240	1.5-3	32-40	12	54.70
BC153-LCC4047	1.5-3	40-47	12	56.60
BC153-LCC4757	1.5-3	47-57	12	65.60
BC38-LCC1219	3-8	12-19	12	54.70
BC38-LCC1926	3-8	19-26	12	56.60
BC38-LCC2632	3-8	26-32	12	59.20
BC38-LCC3240	3-8	32-40	12	62.10
BC38-LCC4047	3-8	40-47	12	63.90
BC38-LCC4757	3-8	47-57	12	72.80
BC814-LCC1219	8-14	12-19	12	56.60
BC814-LCC1926	8-14	19-26	12	58.30
BC814-LCC2632	8-14	26-32	12	60.60
BC814-LCC3240	8-14	32-40	12	63.90
BC814-LCC4047	8-14	40-47	12	65.60
BC814-LCC4757	8-14	47-57	12	74.80
BC1420-LCC1219	14-20	12-19	12	58.30
BC1420-LCC1926	14-20	19-26	12	60.30
BC1420-LCC2632	14-20	26-32	12	62.70
BC1420-LCC3240	14-20	32-40	12	65.60
BC1420-LCC4047	14-20	40-47	12	67.60
BC1420-LCC4757	14-20	47-57	12	76.60

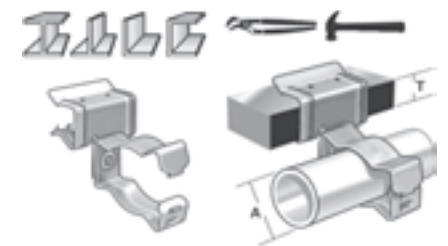

Universal Beam Clip / Snap-In Conduit Clip Combination

Universal Beam Clip with Snap-in Conduit Clip for fixing to horizontal or vertical flanges. Designed to support conduit 18-33mm.

REF	T (mm)	A Ø (mm)	U	PRICE
UBC38-SICC1825	3-8	18-25	11	55.70
UBC38-SICC2229	3-8	22-29	11	56.80
UBC38-SICC2933	3-8	29-33	11	57.40
UBC814-SICC1825	8-14	18-25	11	59.00
UBC814-SICC2229	8-14	22-29	11	59.40
UBC814-SICC2933	8-14	29-33	11	60.30
UBC1420-SICC1825	14-20	18-25	11	64.20
UBC1420-SICC2229	14-20	22-29	11	65.00
UBC1420-SICC2933	14-20	29-33	11	65.60

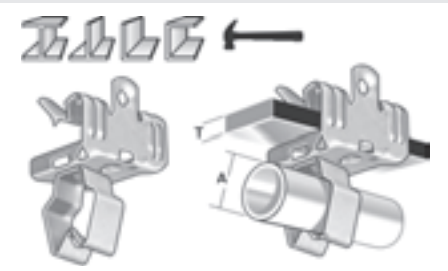

CABLE & TUBE FIXINGS

Universal Beam Clip / Side Mounted Snap-In Conduit Clip Combination

Universal Beam Clip with side mounted Snap-In Conduit Clip for fixing to horizontal or vertical flanges. Conduit is held away from the edge of flange. Designed to support conduit 18-33mm diameter.

REF	T (mm)	A Ø (mm)	U	PRICE
UBC38-SICC1825SM	3-8	18-25	11	55.70
UBC38-SICC2229SM	3-8	22-29	11	56.80
UBC38-SICC2933SM	3-8	29-33	11	57.40
UBC814-SICC1825SM	814	18-25	11	59.00
UBC814-SICC2229SM	814	22-29	11	59.40
UBC814-SICC2933SM	814	29-33	11	60.30
UBC1420-SICC1825SM	14-20	18-25	11	64.20
UBC1420-SICC2229SM	14-20	22-29	11	65.00
UBC1420-SICC2933SM	14-20	29-33	11	65.60

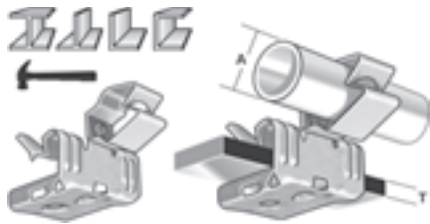

Universal Beam Clip / Locking Conduit Clip Combination

Universal Beam Clip with Locking Conduit Clip for fixing to horizontal or vertical flanges. Conduit is held adjacent to face of flange. Designed to support conduit 12-57mm diameter. Use pliers to lock.

REF	T (mm)	A Ø (mm)	U	PRICE
UBC38-LCC1219	3-8	12-19	45	64.60
UBC38-LCC1926	3-8	19-26	45	66.60
UBC38-LCC2632	3-8	26-32	45	69.00
UBC38-LCC3240	3-8	32-40	25	72.60
UBC38-LCC4047	3-8	40-47	45	73.70
UBC38-LCC4757	3-8	47-57	45	82.70
UBC814-LCC1219	8-14	12-19	45	67.60
UBC814-LCC1926	8-14	19-26	45	69.30
UBC814-LCC2632	8-14	26-32	45	72.00
UBC814-LCC3240	8-14	32-40	45	74.90
UBC814-LCC4047	8-14	40-47	45	76.60
UBC814-LCC4757	8-14	47-57	45	85.70
UBC1420-LCC1219	14-20	12-19	25	72.80
UBC1420-LCC1926	14-20	19-26	45	74.90
UBC1420-LCC2632	14-20	26-32	45	77.10
UBC1420-LCC3240	14-20	32-40	45	80.30
UBC1420-LCC4047	14-20	40-47	45	82.20
UBC1420-LCC4757	14-20	47-57	45	91.10

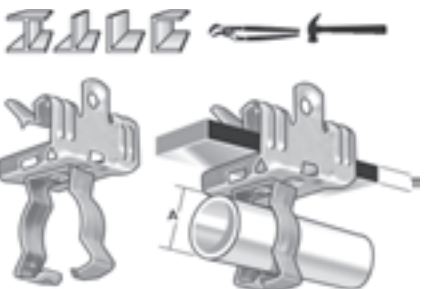

Large Beam Clip / Locking Conduit Clip Combination

Large Beam Clip to suit horizontal flanges from 23-30mm thick with Locking Conduit Clip. Designed to support conduit 12-57mm diameter. Use pliers to lock.

REF	T (mm)	A Ø (mm)	U	PRICE
LBC2330-LCC1219	23-30	12-19	10	64.20
LBC2330-LCC1926	23-30	19-26	10	66.10
LBC2330-LCC2632	23-30	26-32	10	68.50
LBC2330-LCC3240	23-30	32-40	10	71.50
LBC2330-LCC4047	23-30	40-47	10	74.20
LBC2330-LCC4757	23-30	47-45	10	82.30

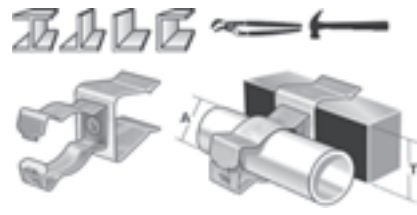

Master Clamp / Snap-In Conduit Clip Combination

Screw Clamp incorporating Snap-in Conduit Clip for horizontal flanges up to 18mm thick. Holds conduit or pipe adjacent to face of flange. Suits conduit or pipe 18-33mm diameter. Conduit Clip swivels 360°.

REF	T (mm)	A Ø (mm)	U	PRICE
SC65-SICC1825	18 Max	18-25	11	78.90
SC65-SICC2229	18 Max	22-29	11	79.50
SC65-SICC2933	18 Max	29-33	11	80.30

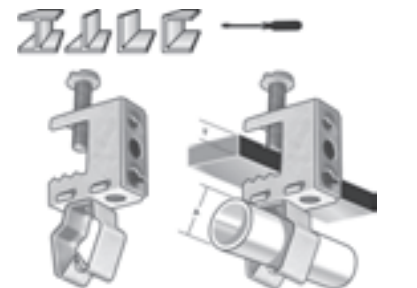

Master Clamp / Side Mounted Snap-In Conduit Clip Combination

Screw Clamp incorporating Side Mounted Snap-In Conduit Clip for horizontal flanges up to 18mm thick. Holds conduit or pipe adjacent to edge of flange. Suits conduit or pipe 18-33mm diameter. Conduit Clip swivels 360°.

REF	T (mm)	A Ø (mm)	U	PRICE
SC107-SICC1825	18 Max	18-25	7	78.90
SC107-SICC2229	18 Max	22-29	7	79.50
SC107-SICC2933	18 Max	29-33	7	80.30

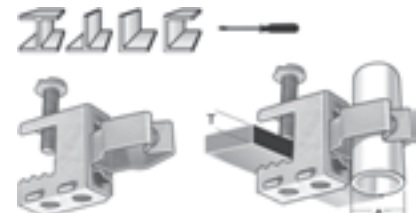

Master Clamp / Locking Conduit Clip Combination

Screw Clamp incorporating Locking Conduit Clip for horizontal flanges up to 18mm thick. Holds conduit or pipe adjacent to face of flange. Suits conduit or pipe 12-57mm diameter. Use pliers to lock. Conduit Clip swivels 360°.

REF	T (mm)	A Ø (mm)	U	PRICE
SC65-LCC1219	18 Max	12-19	45	83.40
SC65-LCC1926	18 Max	19-26	45	85.30
SC65-LCC2632	18 Max	26-32	45	88.20
SC65-LCC3240	18 Max	32-40	45	90.50
SC65-LCC4047	18 Max	40-47	45	91.00
SC65-LCC4757	18 Max	47-57	45	99.00

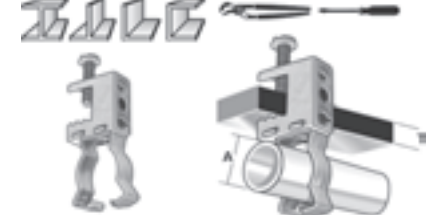

Master Clamp / Side Mounted Locking Conduit Clip Combination

Screw Clamp incorporating side mounted Locking Conduit Clip for horizontal flanges up to 18mm thick. Holds cable, conduit or pipe adjacent to edge of flange. Suits conduit or pipe 12-57mm diameter. Conduit Clip swivels 360°.

REF	T (mm)	A Ø (mm)	U	PRICE
SC107-LCC1219	18 Max	12-19	12	83.40
SC107-LCC1926	18 Max	19-26	12	85.30
SC107-LCC2632	18 Max	26-32	12	88.20
SC107-LCC3240	18 Max	32-40	12	90.50
SC107-LCC4047	18 Max	40-47	12	91.00
SC107-LCC4757	18 Max	47-57	12	99.00



Vertical Flange Clip / Snap-In Conduit Clip Combination

Clips for vertical flanges from 1,5-7mm thick incorporating a Snap-In Conduit Clip for services 18-33mm diameter. Holds services away from face of flange.

REF	T (mm)	A Ø (mm)	U	PRICE
VF155-SICC1825	1.5-5	18-25	11	42.20
VF155-SICC2229	1.5-5	22-29	11	43.20
VF155-SICC2933	1.5-5	29-33	11	43.60
VF57-SICC1825	5-7	18-25	11	42.20
VF57-SICC2229	5-7	22-29	11	43.20
VF57-SICC2933	5-7	29-33	11	43.60

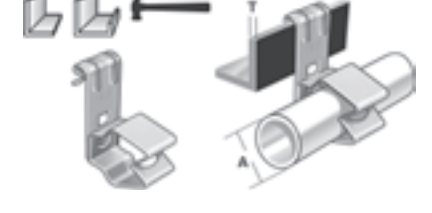

CABLE & TUBE FIXINGS

Vertical Flange Clip / Locking Conduit Clip Combination

Clips for vertical flanges from 1,5-7mm thick incorporating a Locking Conduit Clip for services 12-57mm diameter. Holds services away from face of flange.

REF	T (mm)	A Ø (mm)	U	PRICE
VF155-LCC1219	1.5-5	12-19	25	51.00
VF155-LCC1926	1.5-5	19-26	25	52.80
VF155-LCC2632	1.5-5	26-32	25	55.60
VF155-LCC3240	1.5-5	32-40	25	56.10
VF155-LCC4047	1.5-5	40-47	25	60.30
VF155-LCC4757	1.5-5	47-57	25	69.30
VF57-LCC1219	5-7	12-19	25	51.00
VF57-LCC1926	5-7	19-26	25	52.80
VF57-LCC2632	5-7	26-32	25	55.60
VF57-LCC3240	5-7	32-40	25	56.10
VF57-LCC4047	5-7	40-47	25	60.30
VF57-LCC4757	5-7	47-57	25	69.30

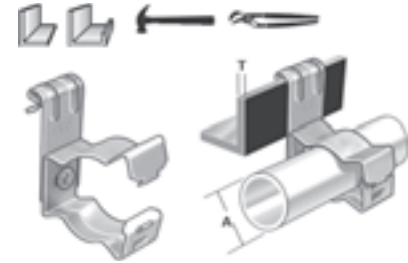

Vertical Flange Clip / Locking Conduit Clip Combination Reversed

Clips for vertical flanges from 1,5-7mm thick incorporating a reversed Locking Conduit Clip for services 12-32mm diameter. Holds services beneath flange, recessed back from face.

REF	T (mm)	A (mm)	B Ø (mm)	U	PRICE
VF155-LCC1219R	1.5-5	MAX20	12-19	12	51.00
VF155-LCC1926R	1.5-5	MAX20	19-26	12	52.80
VF155-LCC2632R	1.5-5	MAX20	26-32	12	55.60
VF57-LCC1219R	5-7	MAX20	12-19	12	51.00
VF57-LCC1926R	5-7	MAX20	19-26	12	52.80
VF57-LCC2632R	5-7	MAX20	26-32	12	55.60

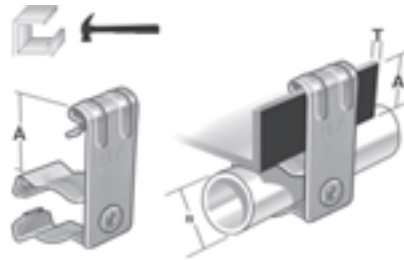

Vertical Flange Clip / Snap-In Conduit Clip Combination Reversed

Clips for vertical flanges from 1,5-7mm thick incorporating a reversed Snap-In Conduit Clip for services 18-33mm diameter. Holds services beneath flange, recessed back from face.

REF	T (mm)	A (mm)	B Ø (mm)	U	PRICE
VF155-SICC1825R	1.5-5	MAX20	18-25	11	42.20
VF155-SICC2229R	1.5-5	MAX20	22-29	11	43.20
VF155-SICC2933R	1.5-5	MAX20	29-33	11	43.60
VF57-SICC1825R	5-7	MAX20	18-25	11	42.20
VF57-SICC2229R	5-7	MAX20	22-29	11	43.20
VF57-SICC2933R	5-7	MAX20	29-33	11	43.60

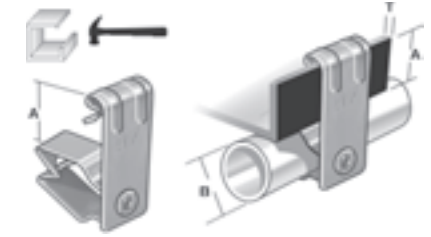

Girder Clip for Multi Cables

Girder Clip to suit horizontal flange from 3-18mm, allows for cable tie attachment.

REF	T (mm)	A (mm)	B (mm)	C (mm)	PRICE
GC310	3-10	52	16	10	22.90
GC1018	10-18	52	16	10	22.90

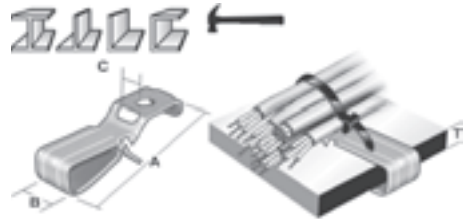

Z-PURLIN HANGERS (45°)

Z-Purlin Flange Clip (45°)

Hammer-on clip for supporting chains etc. to 45° angled steelwork 1.5-5mm. 4.5mm hole receives hook, chain or nut and bolt connection.

REF	T (mm)	A (mm)	B (mm)	C (mm)	D Ø (mm)	S	PRICE
ZPFC155	1.5-5	15	53	15	6.5	45	20.70

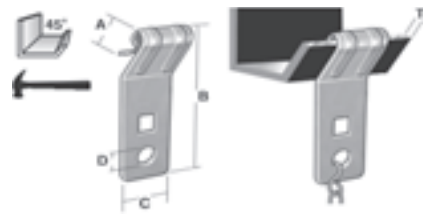

Z-Purlin Flange Clip (45°) / Threaded Rod Hanger Combination

Hammer-on 45° Z-Purlin Flange Clip to suit flange thickness 1.5-5mm. Incorporates Threaded Rod Hanger for rod diameters M6, M8, M10 and M12. RH127 requires nut to secure.

REF	T (mm)	A (mm)	B (mm)	D Ø C° (mm)	S	PRICE
ZPFC155-RH6T	1.5-5	15	77	45° M6	45	47.90
ZPFC155-RH8T	1.5-5	15	77	45° M8	45	47.90
ZPFC155-RH10T	1.5-5	15	77	45° M10	45	47.90
ZPFC155-RH127	1.5-5	15	77	45° 12.7	45	47.90

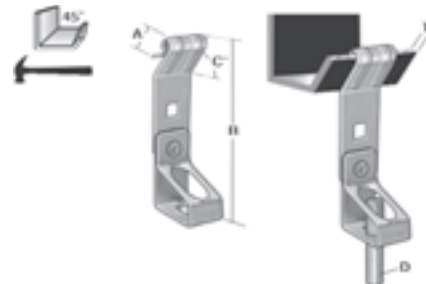

Z-Purlin Hanger (45°) / Locking Conduit Clip Combination

Z-Purlin Hanger incorporating a Locking Conduit Clip. Suits conduit and cable diameters 12-57mm. Conduit clip turns 360°.

REF	A (mm)	B Ø (mm)	S	PRICE
ZPH2-LCC1219	Max 3	12-19	45	60.30
ZPH2-LCC1926	Max 3	19-26	45	62.10
ZPH2-LCC2632	Max 3	26-32	45	65.50
ZPH2-LCC3240	Max 3	32-40	45	67.60
ZPH2-LCC4047	Max 3	40-47	45	69.30
ZPH2-LCC4757	Max 3	47-57	45	78.50



Z-Purlin Hanger (45°)

Z-Purlin Hangers for supporting conduit conjunction boxes, chains etc. to 45° angled steelwork up to 3mm thick.

REF	A (mm)	B (mm)	C Ø (mm)	S	PRICE
ZPH1	Max 3	64	6.5	45	25.80
ZPH2	Max 3	50	6.5	45	25.80

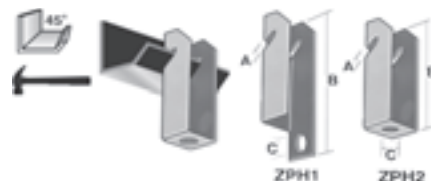

Z-PURLIN HANGERS

Z-Purlin Hanger (45°) / Snap-In Conduit Clip Combination (45°)

Z-Purlin Hanger incorporating a Snap-In Conduit Clip. Suits conduit diameter 18-33mm. Conduit clip turns 360°.

REF	A (mm)	B Ø (mm)	U	PRICE
ZPH2-SICC1825	Max 3	18-22	11	51.00
ZPH2-SICC2229	Max 3	22-29	11	52.20
ZPH2-SICC2933	Max 3	29-33	11	52.90

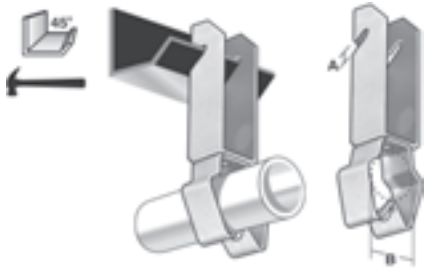

Z-Purlin Hanger (45°) / Cable Tie Saddle Combination

Z-Purlin Hanger incorporating Cable Tie Saddle.

REF	A (mm)	U	PRICE
ZPH2-CTS	Max 3	22	49.30



Z-Purlin Hanger (45°) / Threaded Rod Hanger Combination

Z-Purlin Hanger incorporating Threaded Rod Hanger to suit rod diameter M6, M8, M10 & M12.

REF	A (mm)	B Ø (mm)	S	PRICE
ZPH1-RH6T	Max 3	M6	45	52.40
ZPH1-RH8T	Max 3	M8	45	52.40
ZPH1-RH10T	Max 3	M10	45	52.40
ZPH1-RH12T	Max 3	M12	45	52.40



Z-Purlin Hanger (45°) / Height Adjustable Rod Hanger Combination

Z Purlin Hanger incorporating a Height Adjustable Threaded Rod Hanger to suit threaded Rod diameters M6, M8 & M10.

REF	A (mm)	B Ø (mm)	S	PRICE
ZPH1-TRH6	Max 3	M6	45	52.20
ZPH1-TRH8	Max 3	M8	45	52.20
ZPH1-TRH10	Max 3	M10	45	52.20

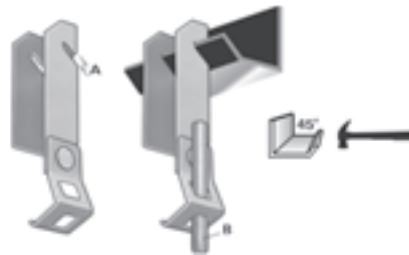

CABLE TIE FIXINGS

Vertical Flange Clip / Cable Tie Saddle Combination

Clips for vertical flanges 1.5-7mm thick incorporating Cable Tie Saddle for cable tie attachment

REF	T (mm)	A (mm)	B (mm)	U	PRICE
VF155-CTS	1.5-5	9	3.5	22	40.20
VF155-CTSR	1.5-5	9	3.5	22	40.20
VF57-CTS	5-7	9	3.5	22	40.20
VF57-CTSR	5-7	9	3.5	22	40.20

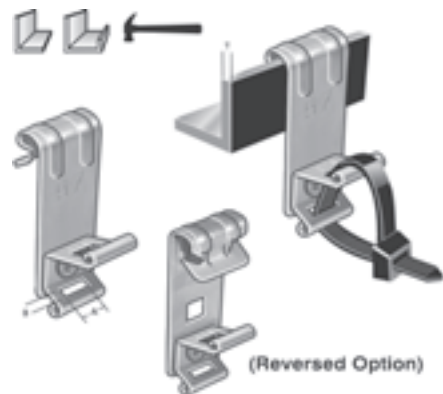

Cable Tie Saddle

Loose Cable Tie Saddle for use as a mounting base for cable ties.

REF	A (mm)	B (mm)	C Ø (mm)	PRICE
CTS	9	3.5	6.5	11.40



Large Beam Clip / Cable Tie Saddle Combination

A simple cost-effective solution for fixing onto oversized steelwork. Grips firmly onto flanges up to 30mm incorporating Cable Tie Saddle for cable tie attachment.

REF	T (mm)	A (mm)	B (mm)	U	PRICE
LBC2330-CTS	23-30	9	3.5	20	53.60



Beam Clip / Cable Tie Saddle Combination

Beam Clip to suit horizontal flange from 1.5-20mm with Cable Tie Saddle for cable tie attachment

REF	T (mm)	A (mm)	B (mm)	U	PRICE
BC153-CTS	1.5-3	9	3.5	22	36.40
BC38-CTS	3-8	9	3.5	22	43.60
BC814-CTS	8-4	9	3.5	22	45.40
BC1420-CTS	14-20	9	3.5	22	47.30

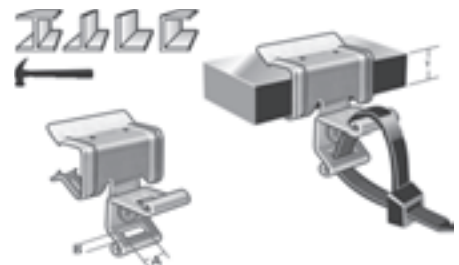

STRAP HANGERS

Strap Hanger

Strap Hanger with 6.5mm diameter hole for fixing to vertical surfaces. Suitable for straps up to 28mm wide.

REF	A (mm)	B (mm)	C (mm)	D Ø (mm)	PRICE
SH	28	6.3	18	6.5	90 20.00
SHR	28	6.3	34	6.5	90 29.80

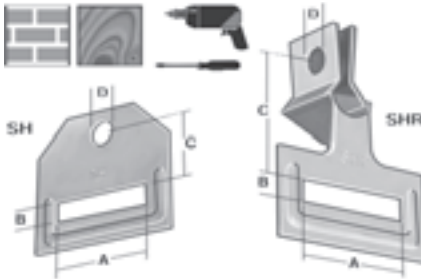

Vertical Flange Clip / Strap Hanger Combination

Strap Hanger Clip for fixing onto vertical flanges 1.5-7mm thick. Suits strap width up to 28mm, running parallel to edge of flange.

REF	T (mm)	A (mm)	B (mm)	C (mm)	PRICE
VF155-SH	1.5-5	28	6.3	62	72 47.30
VF57-SH	5-7	28	6.3	62	72 47.30

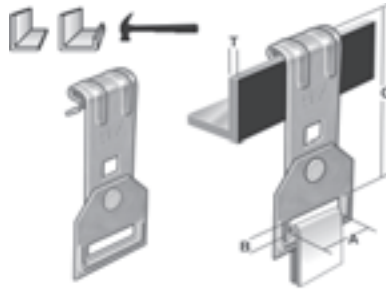

Right Angle Bracket / Strap Hanger Combination

Angle bracket for soffit fixing, incorporating strap hanger to suit strap width up to 28mm. Two versions available.

REF	A (mm)	B (mm)	C (mm)	D Ø (mm)	PRICE
RAB26-SH	28	6.3	38	6.5	90 36.40
RAB44-SH	28	6.3	54	6.5	90 38.40
RAB26-SHR	28	6.3	54	6.5	90 45.50
RAB44-SHR	28	6.3	72	6.5	90 47.30

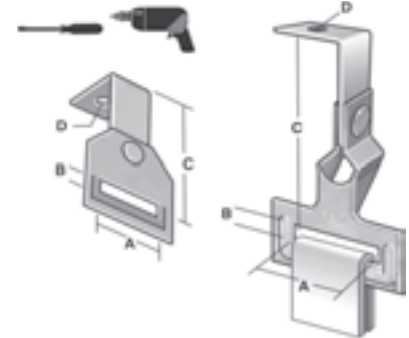

Beam Clip / Strap Hanger Combination

Strap Hanger for fixing to horizontal flanges 1.5-20mm thick. Suits strap width up to 28mm, running parallel to edge of flange.

REF	T (mm)	A (mm)	B (mm)	C (mm)	PRICE
BC153-SH	1.5-3	28	6.3	36	72 43.60
BC38-SH	3-8	28	6.3	38	90 51.00
BC814-SH	8-14	28	6.3	46	90 52.80
BC1420-SH	14-20	28	6.3	58	90 56.70

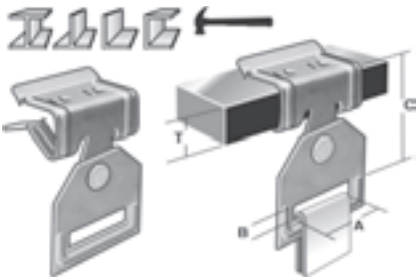

Vertical Flange / Right Angle Strap Hanger Combination

Right Angle Strap Hanger for fixing onto vertical flanges 1-7mm thick. Suits strap width up to 28mm, running at right angle to edge of flange.

REF	T (mm)	A (mm)	B (mm)	C (mm)	PRICE
VF155-SHR	1.5-5	28	6.3	77	72 56.80
VF57-SHR	5-7	28	6.3	77	72 56.80

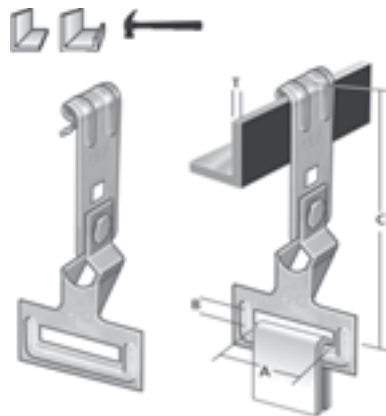

Z-Purlin Hanger 45° / Strap Hanger Combination

Z-Purlin Hanger incorporating Strap Hanger Support for strap up to 25mm wide.

REF	A (mm)	B (mm)	C (mm)	D (mm)	PRICE
ZPH1-SH	Max 3	88	28	6.3	45 56.70
ZPH1-SHR	Max 3	115	28	6.3	45 65.60

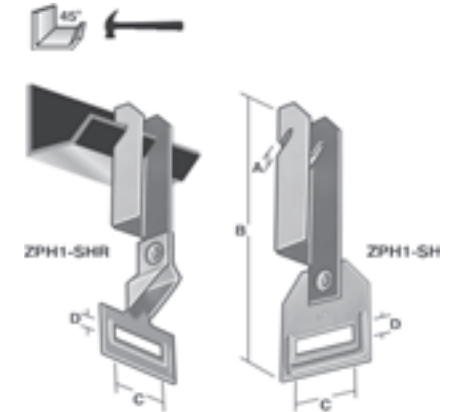

Beam Clip / Right Angle Strap Hanger Combination

Right Angle Strap Hanger for fixing to horizontal flanges 1.5-20mm thick. Suits strap width up to 28mm, running at right angle to edge of flange.

REF	T (mm)	A (mm)	B (mm)	C (mm)	PRICE
BC153-SHR	1.5-3	28	6.3	58	72 52.80
BC38-SHR	3-8	28	6.3	60	90 60.30
BC814-SHR	8-14	28	6.3	68	90 62.10
BC1420-SHR	14-20	28	6.3	80	90 63.90

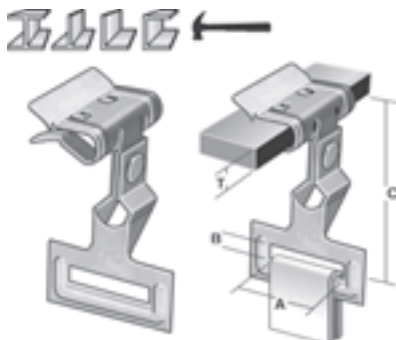

CLAMPS/MISCELLANEOUS

Ceiling Clip / Spin Nut

XC25-16S Ceiling Clip is a special centre rotating clamp on clip for ceiling "T" bars. Supplied with 16mm long M6 threaded stud as standard. WN6 spin nuts supplied separately.

Ref	A (mm)	B (mm)	C Ø (mm)	Weight (kg)	PRICE
XC25-16S	25	16	M6	22	22.50
WN6	-	-	M6		5.60

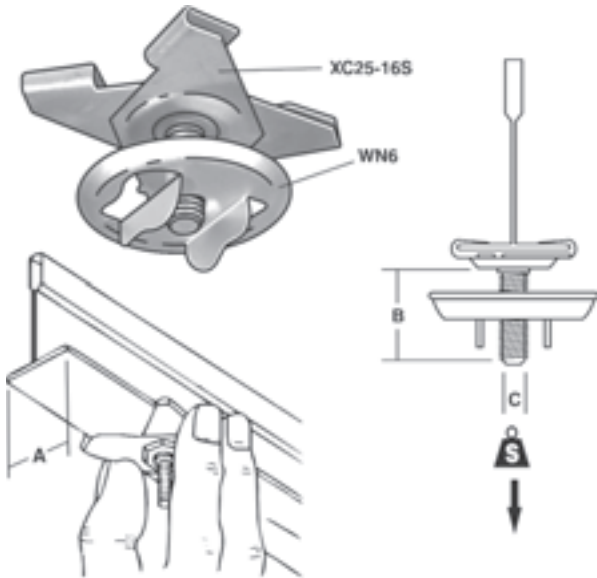

Heavy Duty Swivel Hanger

Offers high load bearing capacity whilst removing the need to bend threaded rod. Accepts both M8 and M10 rods.

REF	T (mm)	A (mm)	B (mm)	C (mm)	D Ø (mm)	E Ø (mm)	Weight (kg)	PRICE
HDSH	Max 25	60	71	12	10	M8/M10	200*	167.30

*Note: Vertical Load

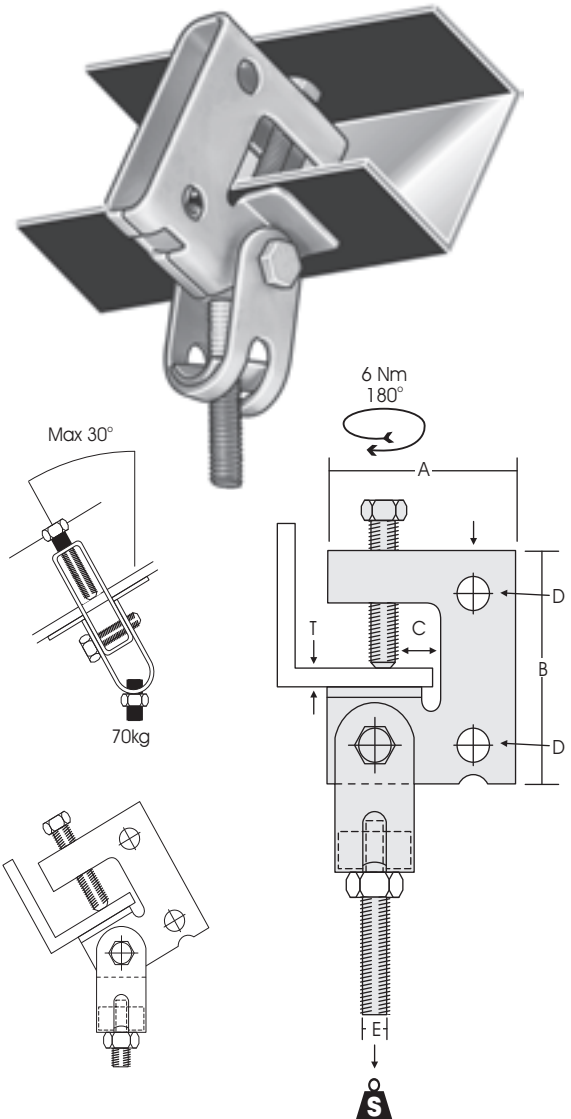

Right Angle Bracket

Basic bracket for horizontal soffit fixing. 6.5mm hole receives hook, chain or nut and bolt connection. Standard finish EG

REF	A (mm)	B (mm)	C Ø (mm)	D Ø (mm)	Weight (kg)	PRICE
RAB-26	26	26	6.5	4.6	90	4.60
RAB-44	44	28	6.5	-	90	7.30

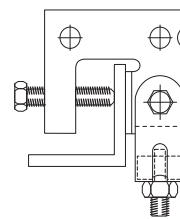
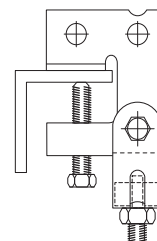
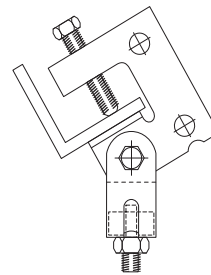
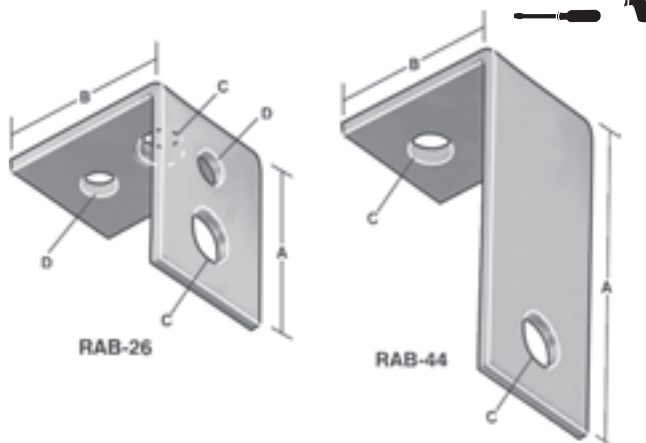

BEAM CLAMPS ARE NOT RECOMMENDED FOR USE IN THE VERTICAL PLANE

